

LUCAS

001 / 11/07/2023



BOOKCASE LARGE HHS

ART CODE: 445 23 201

bopita®

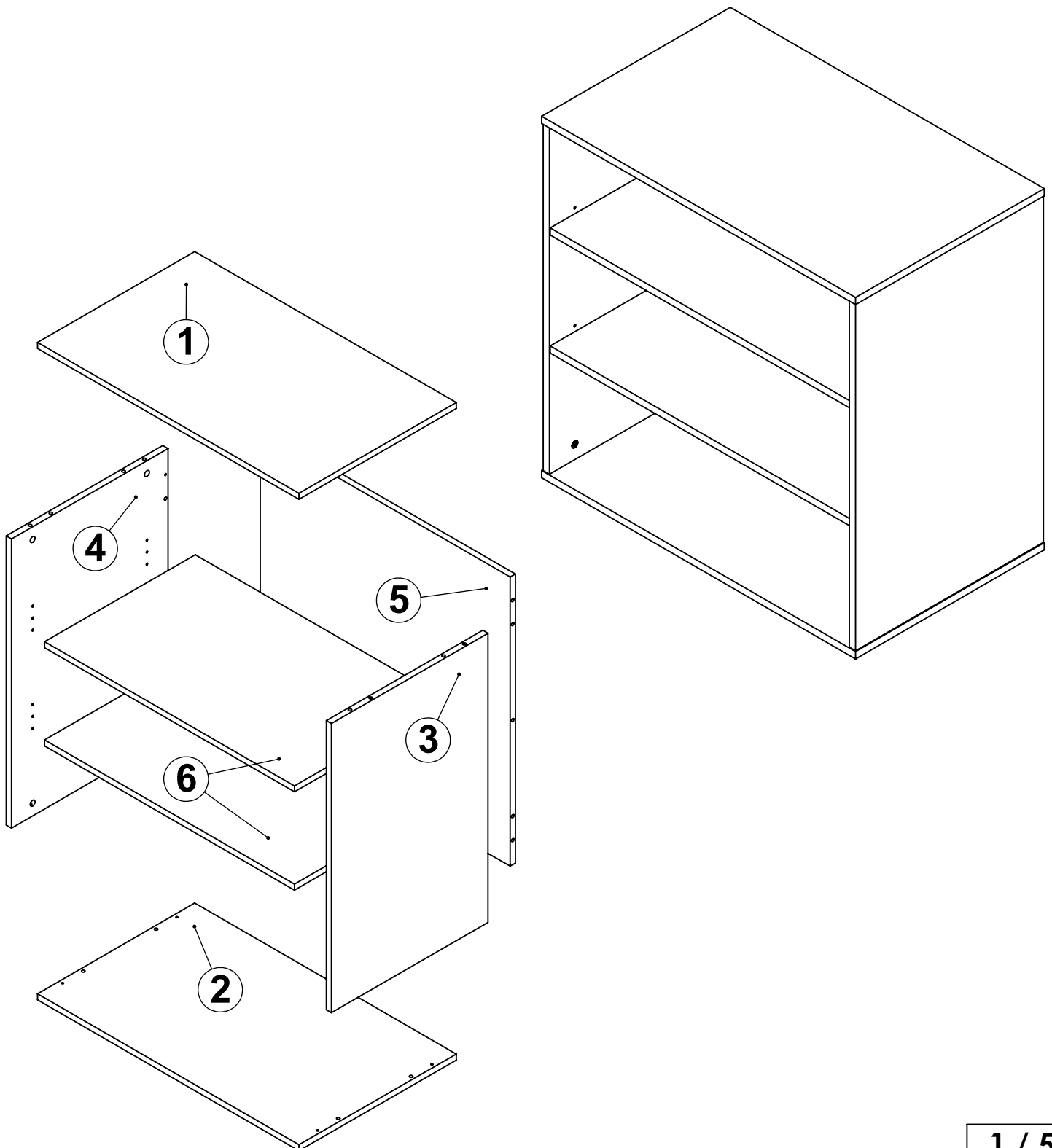
"BOPITA"
LION INTERNATIONAL B.V.
ENERGIEWEG 1
6662 NS ELST GLD
NEDERLAND
www.bopita.com

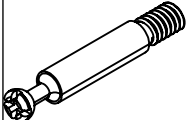
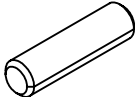
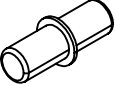
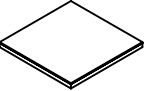

		 8x30			
A x 14	B x 14	C x 12	D x 8	E x 4	IMBUS

BEFORE ASSEMBLY

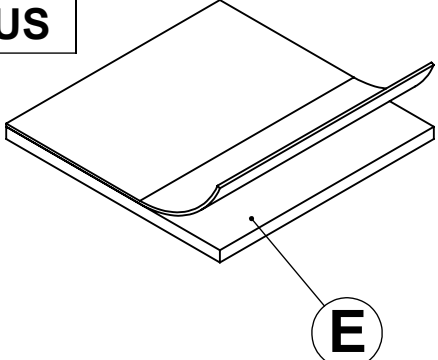

E

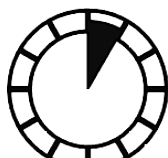
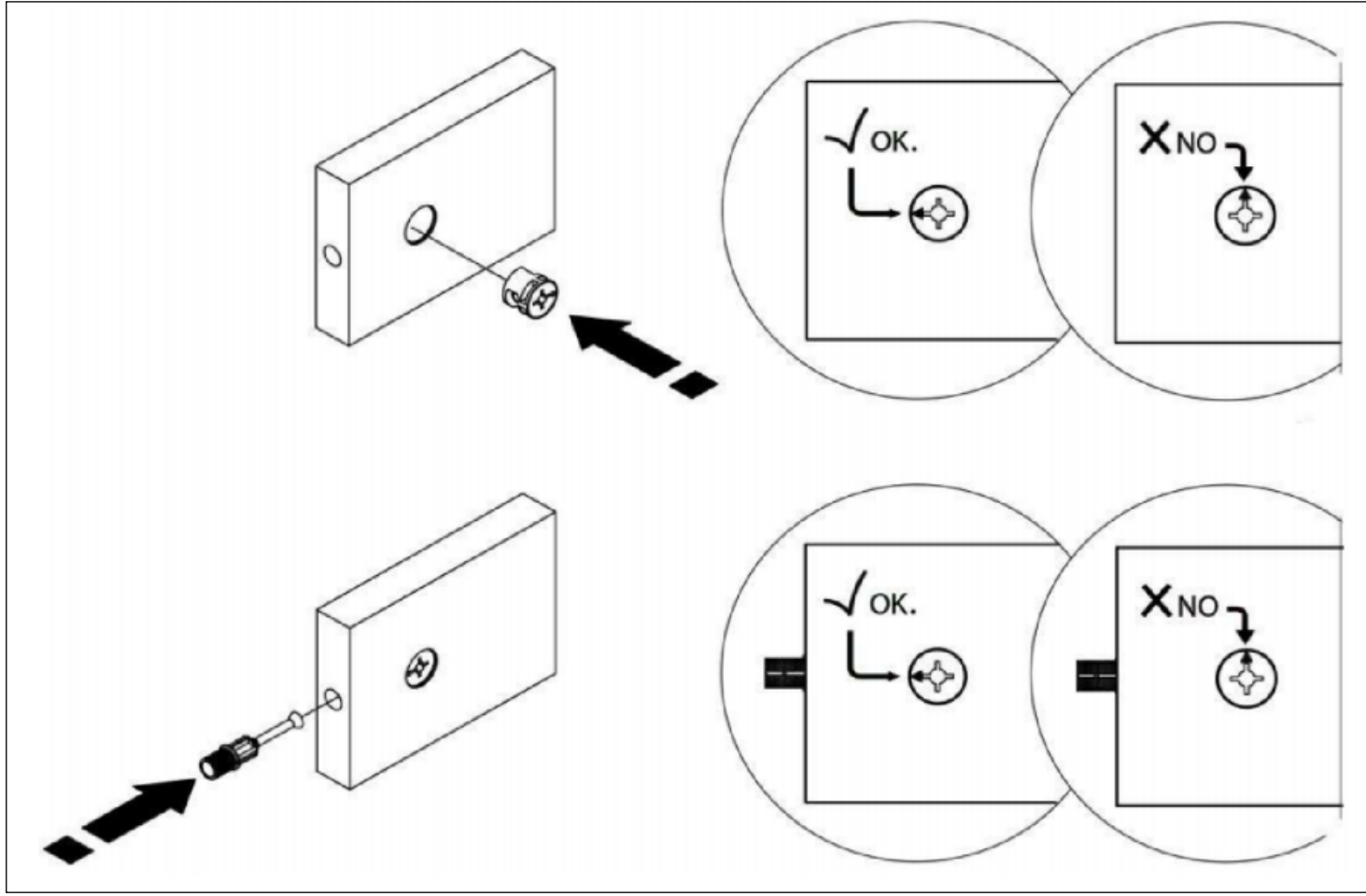
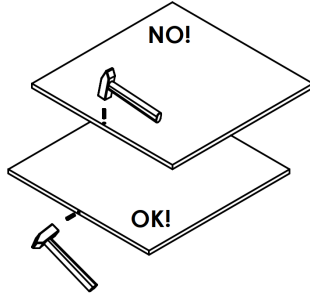
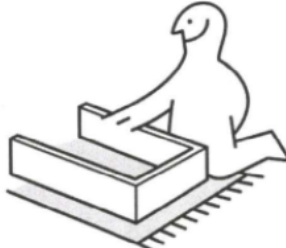
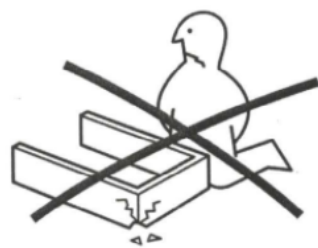

45 min.

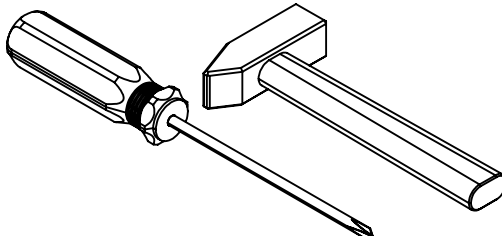

STEP - 1



Ax14

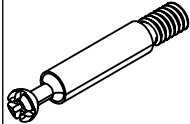

Bx14

8x30

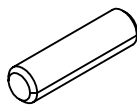

Cx12

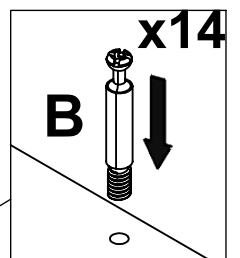
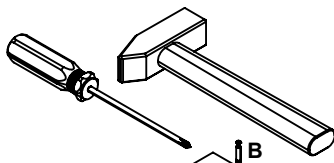

x14

B

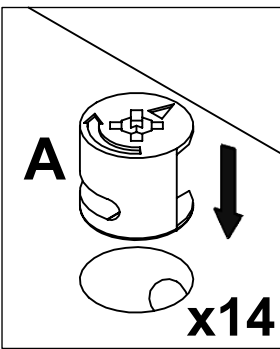

A

x14

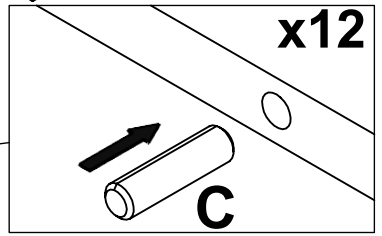
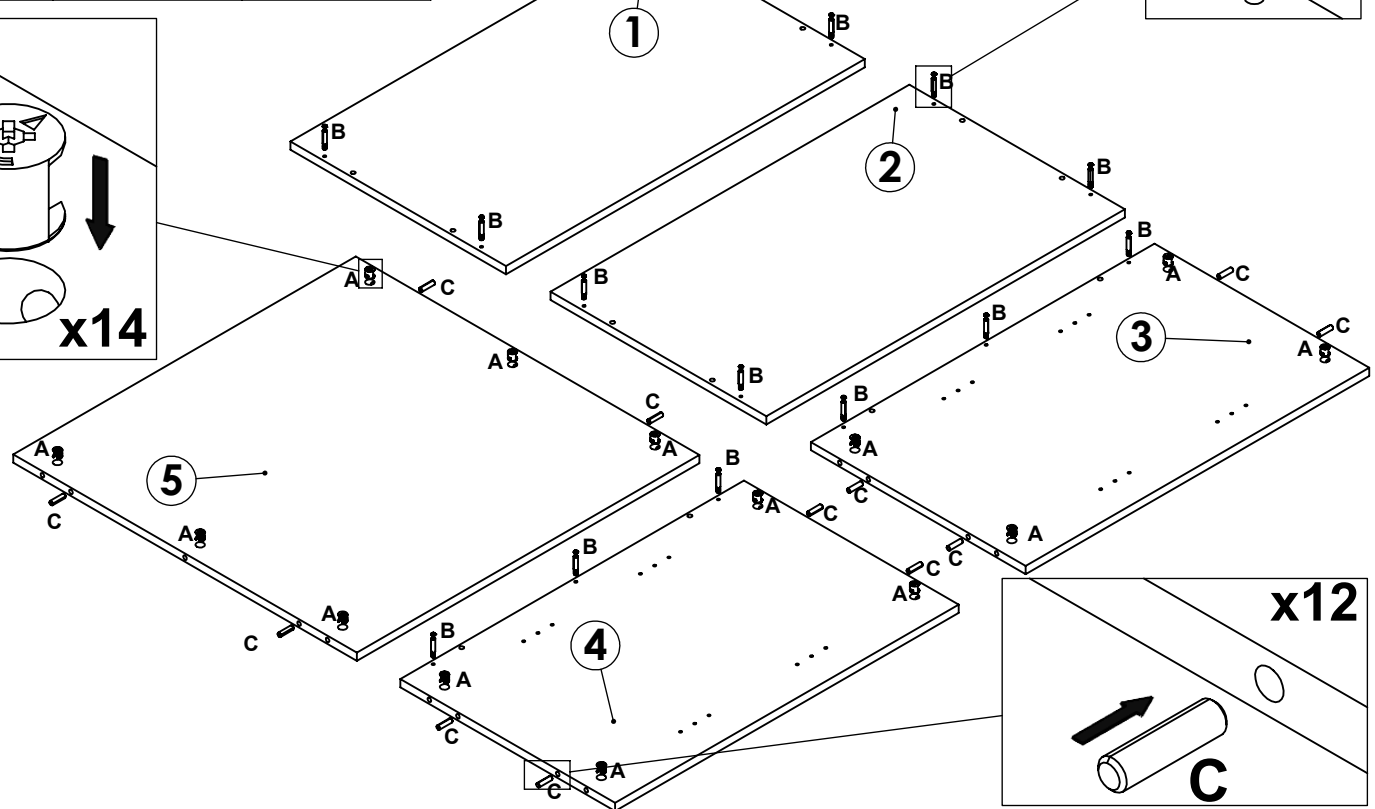

x12

C

STEP - 2

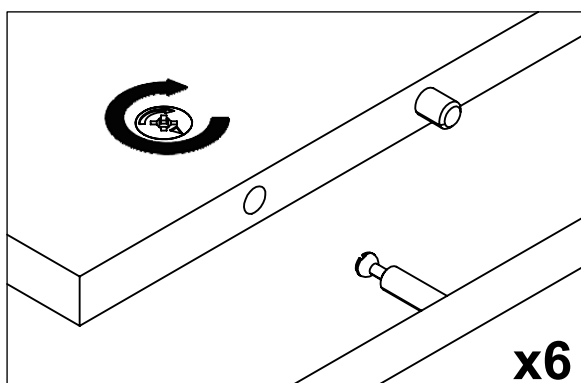
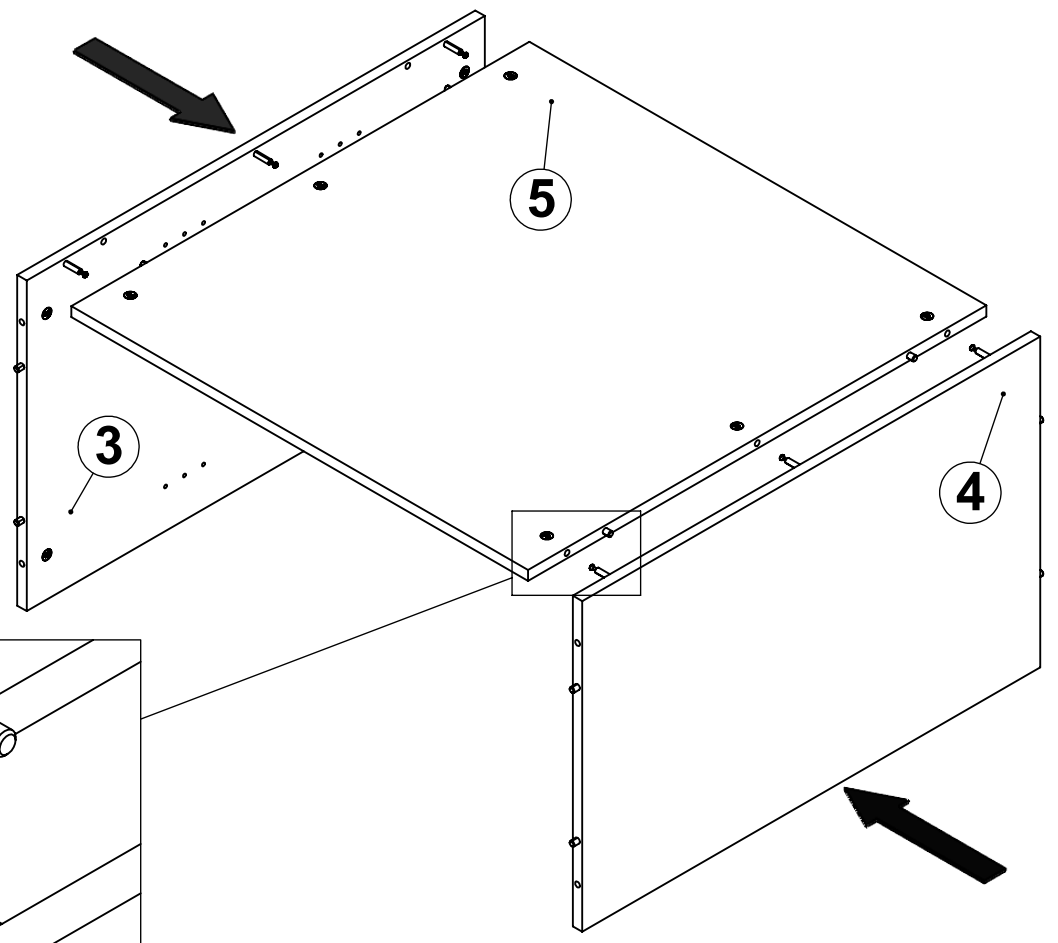
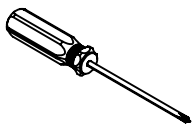

x6

STEP - 3

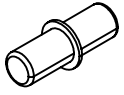

Dx8

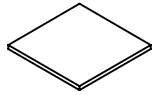

Ex4

x8

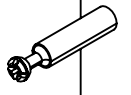

x8

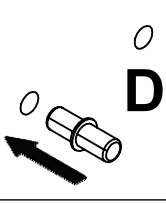

D

x4

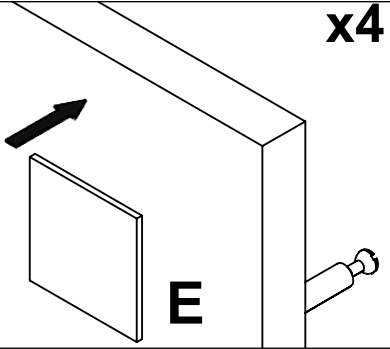

E

1

2

STEP - 4

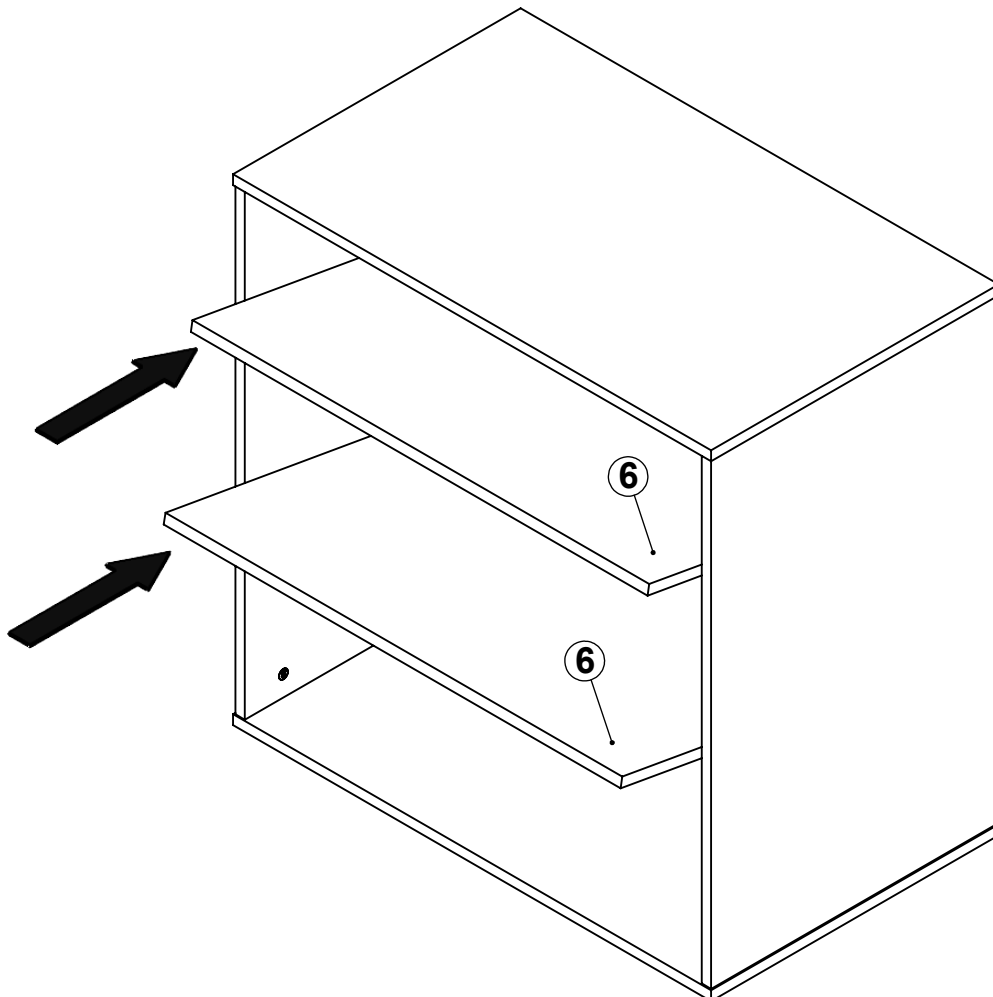

6

6

QC-CODE

(UK) for service requests

(NL) voor service vragen

(FR) pour les demandes de service

(DE) für Service Anfragen

(ES) para consultas de servicio

(IT) per richieste di assistenza

